



## Q1 2022 CONSOLIDATED SALES REVENUES

10 MAY 2022

**indelB**

# GROUP STRUCTURE

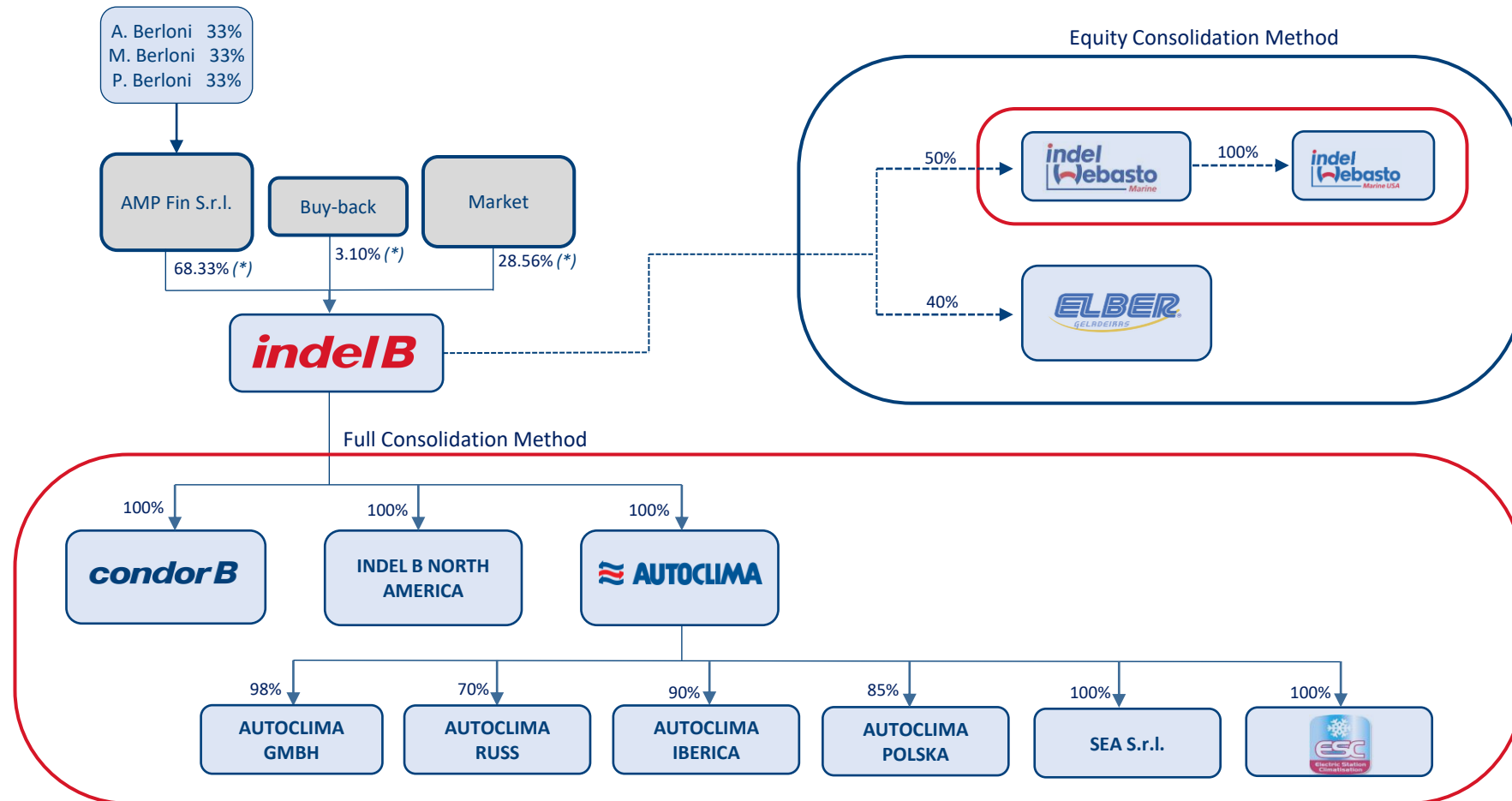

Note: SEA S.r.l. has been acquired on May 10<sup>th</sup>, 2021

(\*) data updated to April 28<sup>th</sup>, 2022

# Q1 2022 SALES

(€ mln)

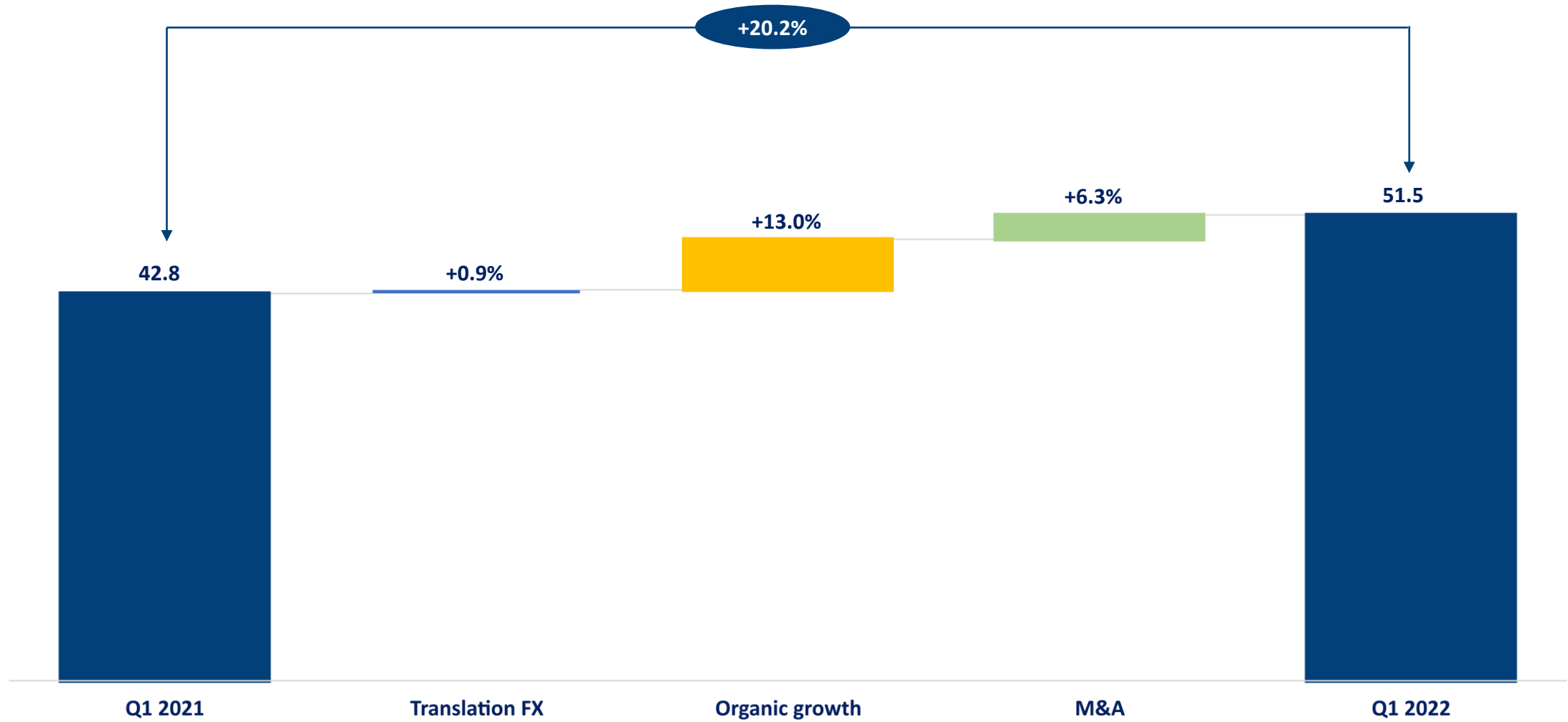

# Q1 2022 SALES BY CHANNEL

(€ mln)

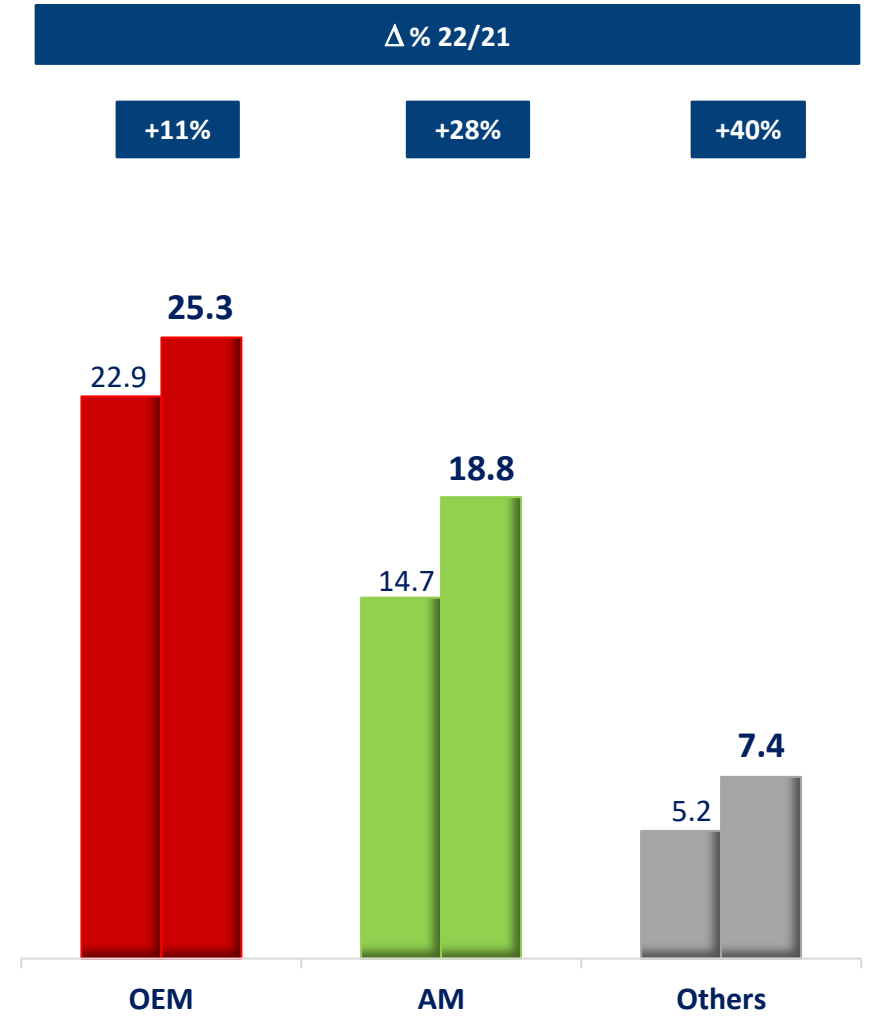
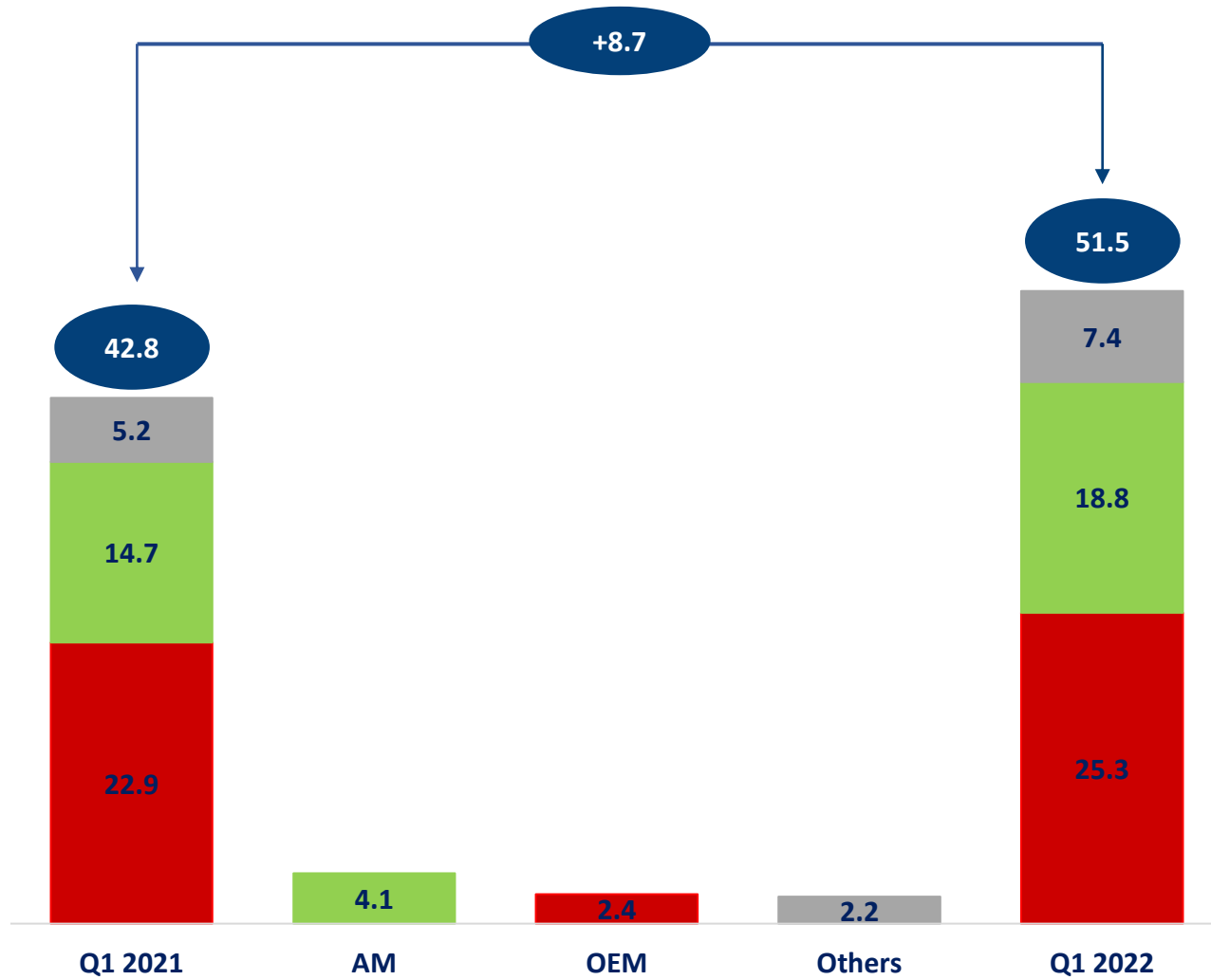

# Q1 2022 SALES BY MARKET

(€ mln)

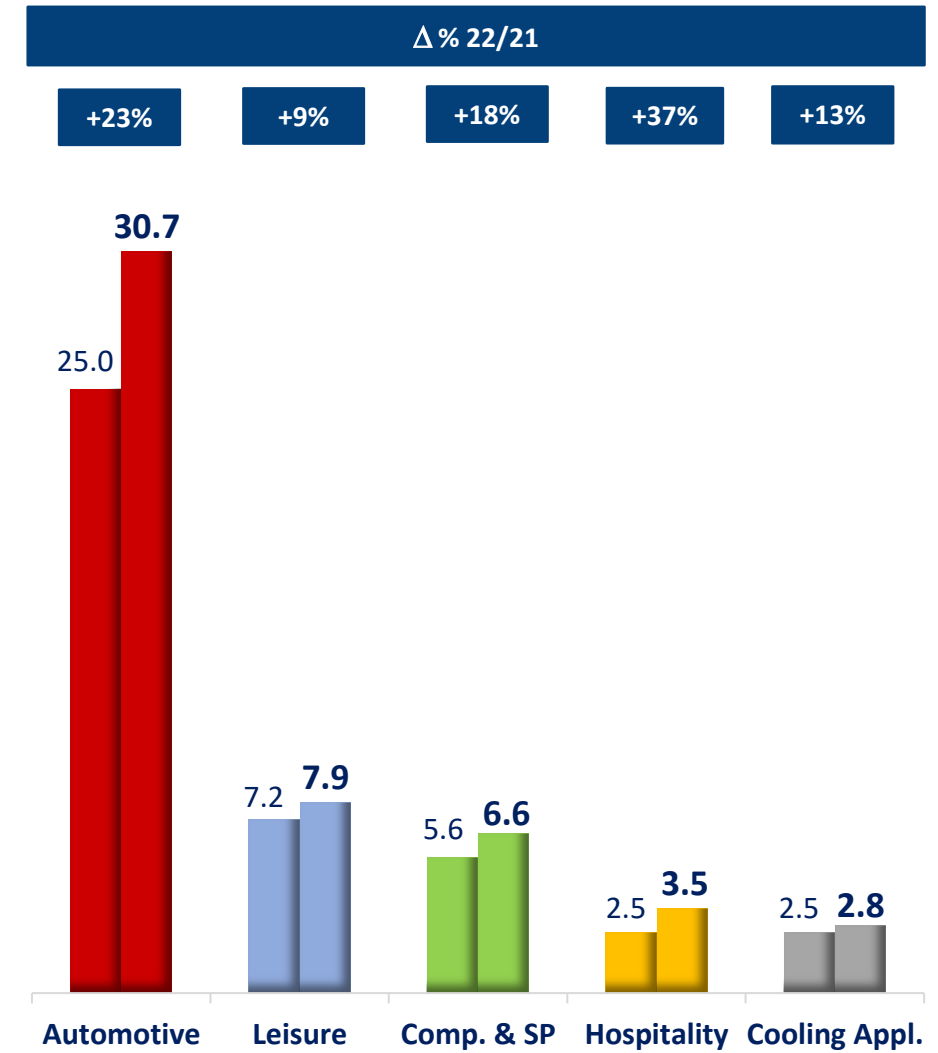
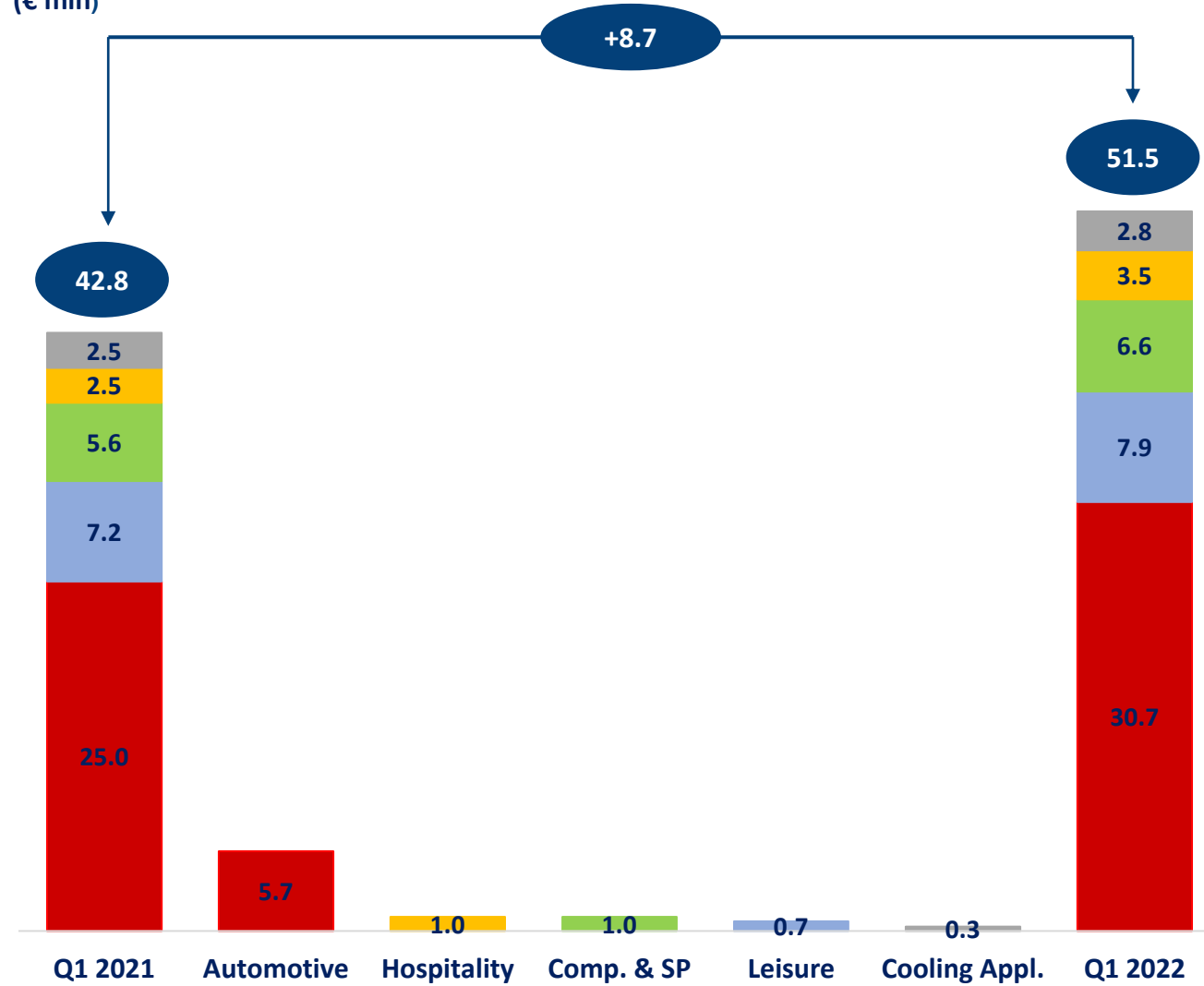

# Q1 2022 SALES BY REGION

(€ mln)

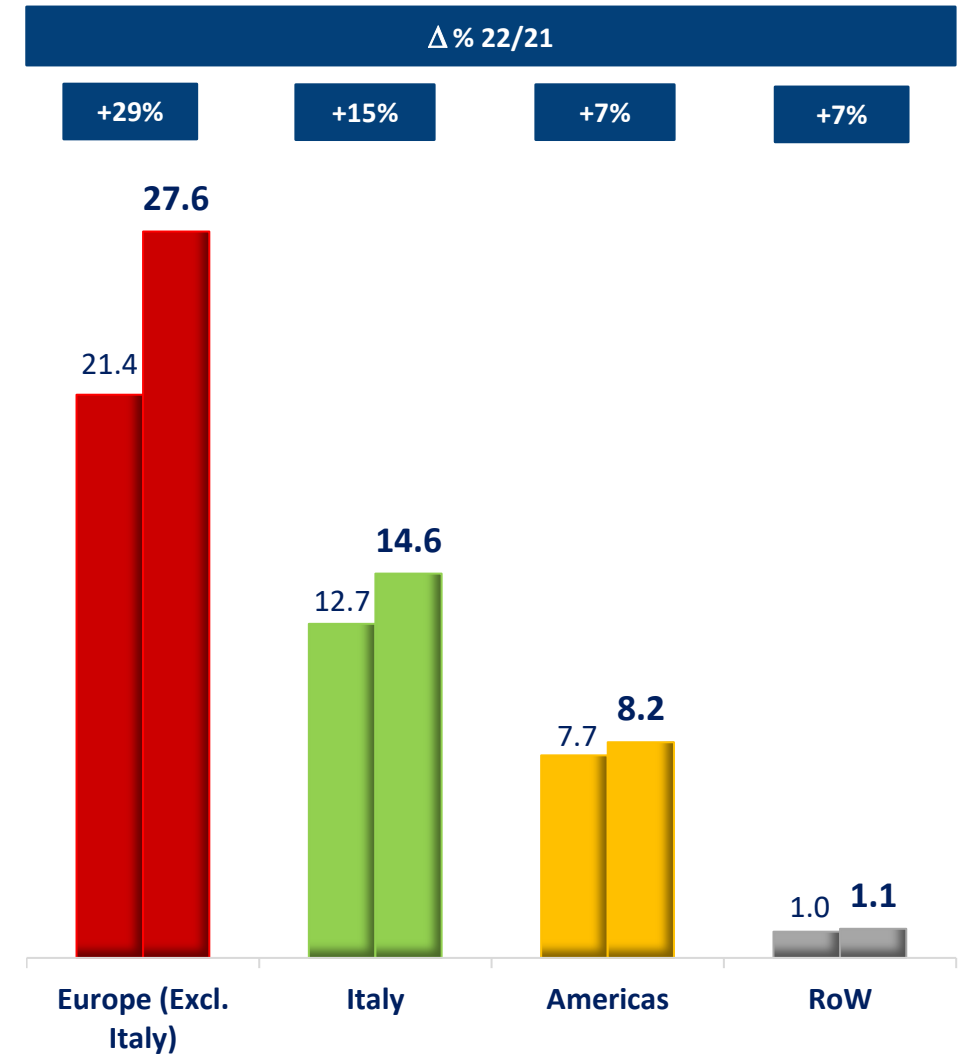
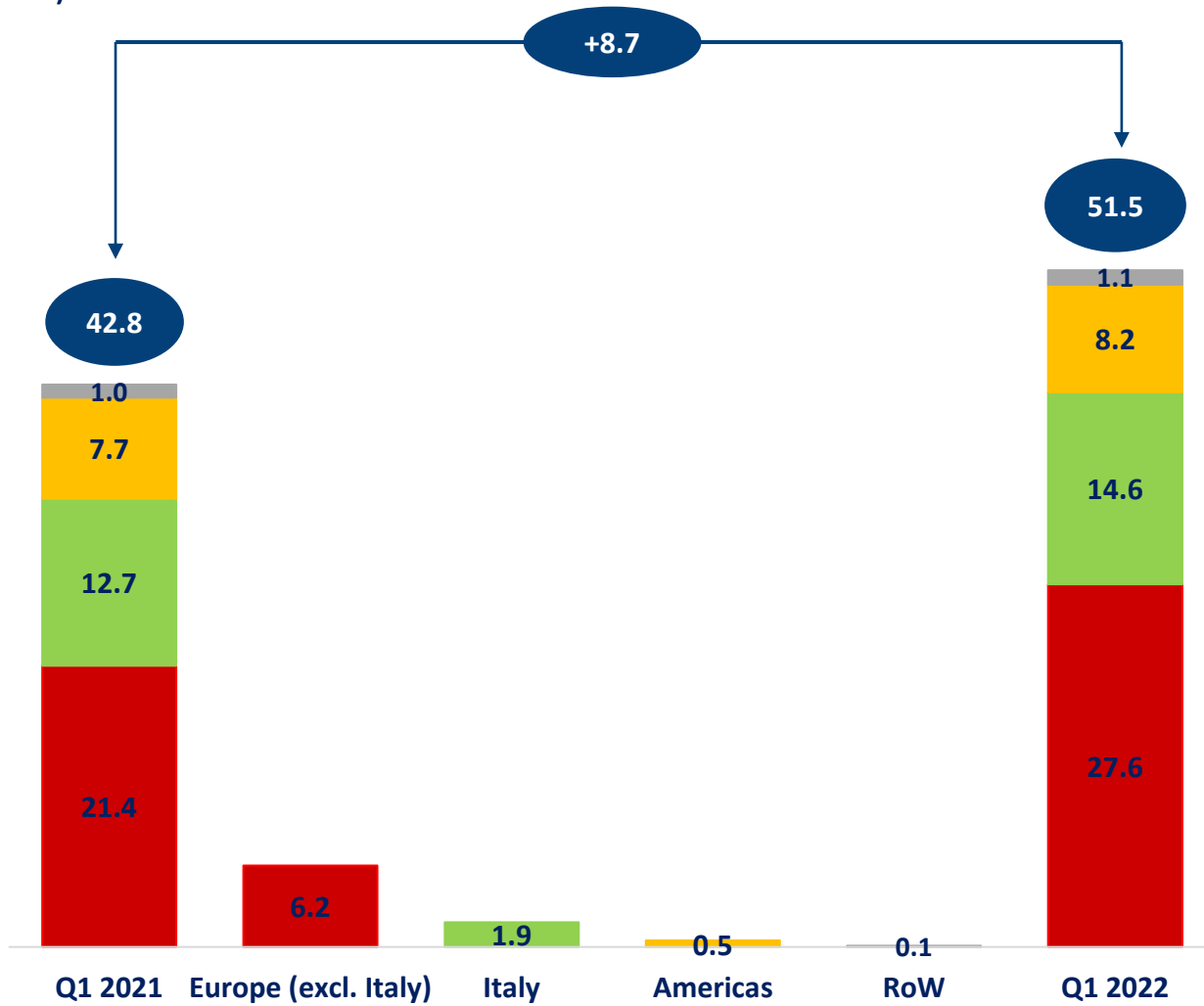

# SALES - BREAKDOWN

## Q1 2022

BY CHANNEL

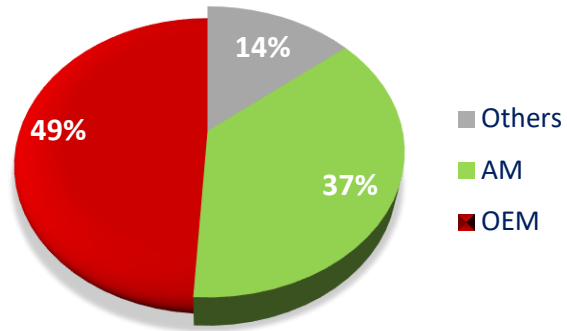

BY MARKET

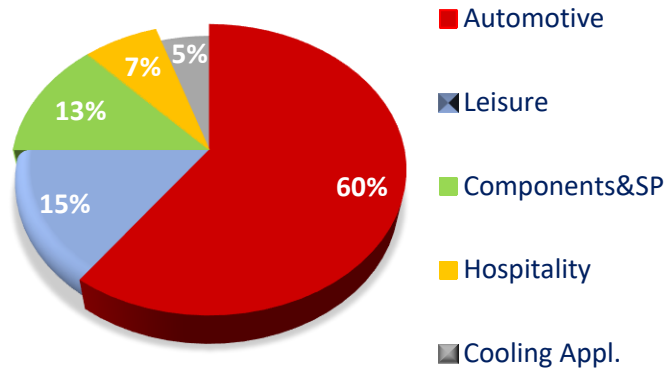

BY REGION

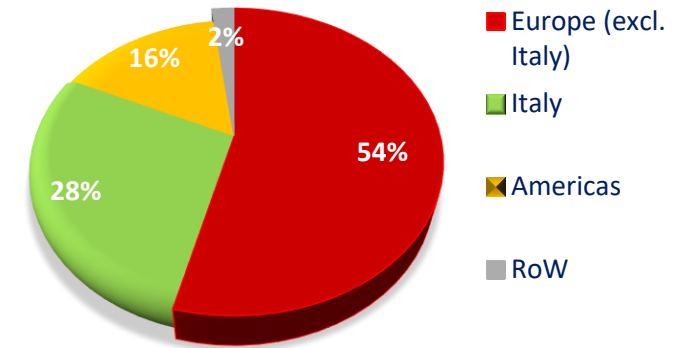

## Q1 2021

BY CHANNEL

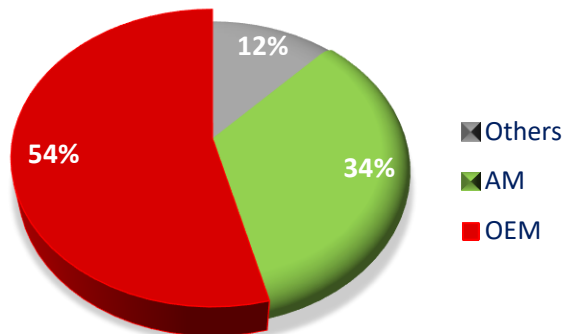

BY MARKET

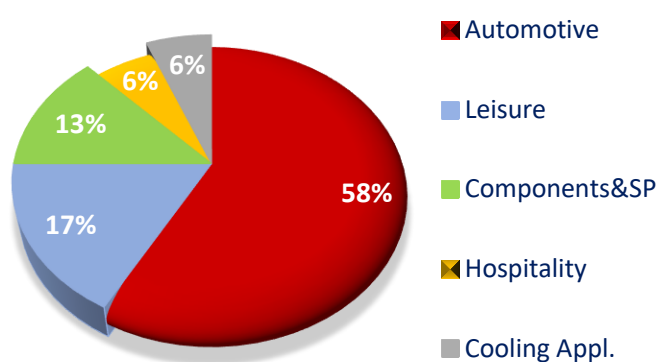

BY REGION

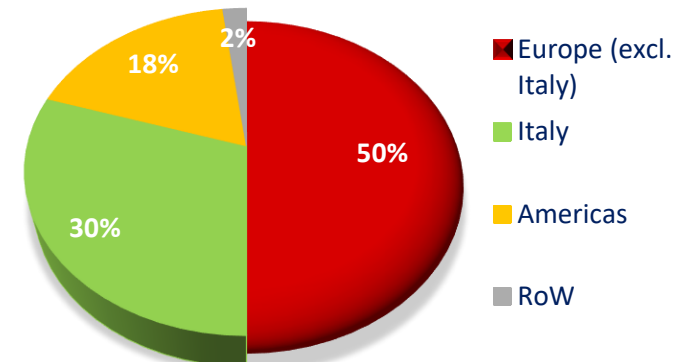

## Shareholding Structure

*(situation updated as of April 28<sup>th</sup>, 2022)*

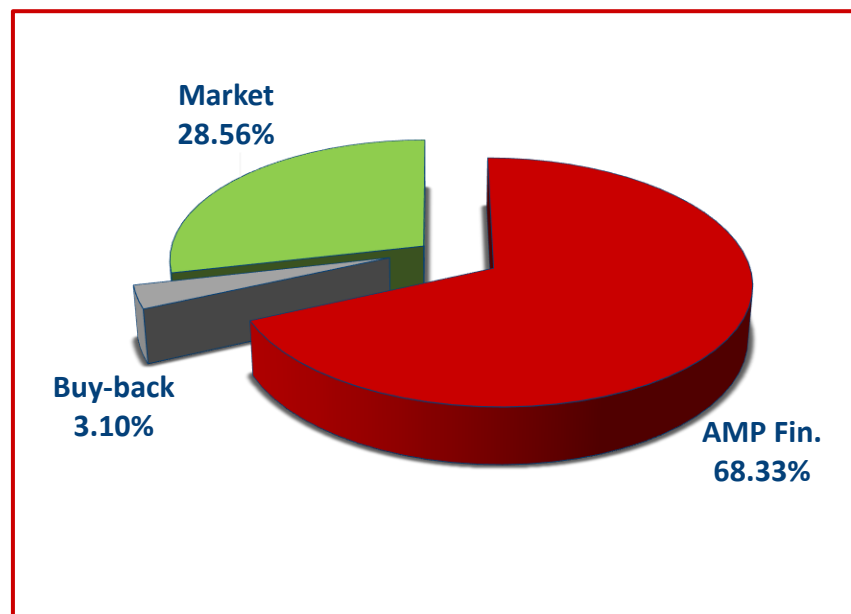

## Contacts:

### Investor Relations:

Elisabetta Benazzi

T: +39 0541 848784

e-mail: [investor.relations@indelb.com](mailto:investor.relations@indelb.com)

### Media relations:

#### POLYTEMS HIR S.r.l

Paolo Santagostino

T: +39 349 3856585

e-mail: [p.santagostino@polytemshir.it](mailto:p.santagostino@polytemshir.it)

### On the web:

[www.indelbgroup.com](http://www.indelbgroup.com)



This document (the Document), which has been drawn up by Indel B S.p.A. (Indel B), is strictly private and confidential and should not be circulated to third parties without the prior written consent of Indel B.

The Document is furnished for information purposes only without any claims to being exhaustive. Indel B accepts no responsibility for the correctness, accuracy and/or completeness of the information contained herein.

The Document was prepared exclusively in order to present Q1 2022 Consolidated Sales Revenues Presentation. Neither the Document nor any of its contents may be used for any other purpose without the prior written consent of Indel B.

This Document in no way constitutes a proposal to execute a contract, a solicitation, advice or recommendation to purchase or sell any financial instrument. The Document does not represent an outright offer or a commitment on the part of Indel B to subscribe for a financial instrument of any kind.

Neither Indel B nor its Group nor any of their directors, general management, staff and advisors may in any way be held responsible for any direct and/or indirect damages that may be suffered by third parties who relied on the statements made in or omitted from the Document. All liability deriving directly or indirectly from use of the Document is hereby expressly disclaimed.

THANK YOU FOR  
YOUR ATTENTION

